

### PRODUCT DESCRIPTION



 WTM190TR is a multi-touch touch monitor based on PCT touch technology. It applies flat panel design, wide viewing angles and clear, crisp images. Its slim design makes more aesthetic, and high integration.

Typical Applications:

Amusement and Entertainment Device, KIOSK, Self-service Terminal, Interactive Digital Signage, Gambling Machine, E-desk, etc.

### ADVANTAGES

#### Easy to Deploy

Plug-and-play. Adapts to universal power :12V DC

#### High Definition

Full HD 1280 x 1024 resolution

#### Bearable and Professional Design

Totally mental construction and Plastic frame, Graceful appearance. To emphasize the content facing users

#### Embedded Design

Convex frame design, embedded in the installation time and external flush structure to form a flat surface, more beautiful

#### PCT multi-touch film

Superior touch experience and a unique touch signal penetration performance, to ensure touch function working with or without gloves

#### Flexible Installation

VESA mount, embed and other installation methods to choose freely

#### Extended multi-touch gestures

Support Windows touch gesture package.

#### Perfect various operating system support

Windows 7 /8, Android , Linux

### TECHNICAL SPECIFICATIONS LCD

#### > LCD Panel

Backlight	LED
Brightness	250 cd/m <sup>2</sup>
Contrast Ratio	1000:1
Viewing Angle	H:170° / V:160°
Response Time	5 ms (GTG)
Supported Colors	16.7M Colors
Display Resolution	1280 x 1024 (4:3)
Display Frame Rate	60Hz
Input Resolution	1280 x 1024 @ 60Hz ( Analog ) 1280 x 1024 @ 60Hz ( Digital )
Connector	1x VGA /1x DVI /1x HDMI

#### > Mechanical

Dimensions	431 x 355.8 x 42.5 mm
Package Dimension	531 x 155 x 473 mm

Weight(approximately)	4.5 kg / 6.5 kg
Wall Mount Type	VESA,MIS-D,75/100,C

#### > OSD Functions

OSD Control	Push Button
OSD Language	English, Chinese

#### > Electrical

Power Supply	DC in: DC 12V (50/60 Hz)
Normal Operation	≤ 16W (typ.)
Power Off	≤ 2 W (typ.)
Internal Speaker	no

#### > Environmental

Operation	0 °C ~ 40 °C, 90% RH
Storage	-20 °C ~ 60 °C, 90% RH

#### > Options

Other	Wall mounts
-------	-------------

### TECHNICAL SPECIFICATIONS TOUCH

Glass	3 mm Black silk screen,ESG
Touch points	10
Touch technology	Projected Capacitive (PCT)
Stylus type	Finger, gloved hand, conductive stylus
Water Resistance	Unaffected by water droplets or condensation

Calibration	No calibration tool
Response time	7ms - 12ms
Connection	USB 2.0 (B socket)
Multi-touch protocol support	Windows
Operating System	Win 7/8,Android,Linux

#### Shanghai Headquarter



TEL: +86 (0)21-58361091  
400-621-1510  
ADD: Room 6206-6207, Building 6, NO.1687 Changyang Road, Yangpu District ,Shanghai, China

#### Beijing Office



TEL: +86 (0) 10-81786110  
ADD: Room 1001,Unit 5,Building 2, Tiantongyuan North Second District,Changping District,Beijing,China



Learn more at: [www.any-touch.com](http://www.any-touch.com) ,email us at: [sales@any-touch.com](mailto:sales@any-touch.com)  
Specifications subject to change without notice.  
Copyright © 2017 Anytouch Technologies Co., LTD



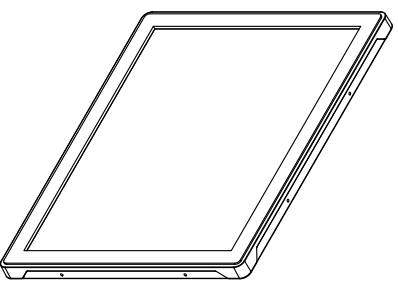
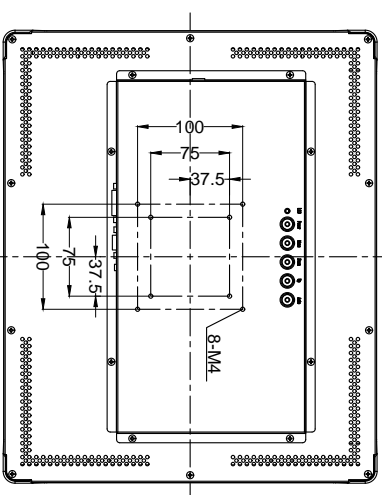
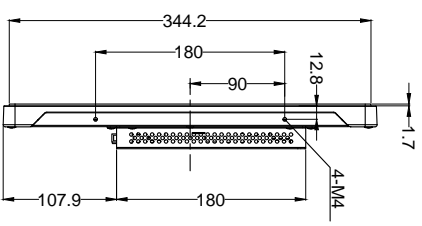
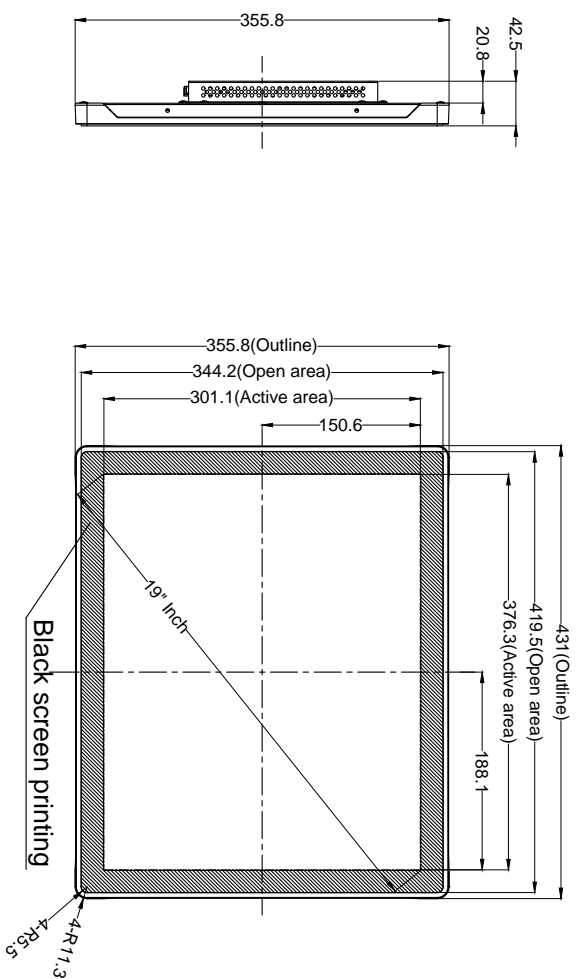
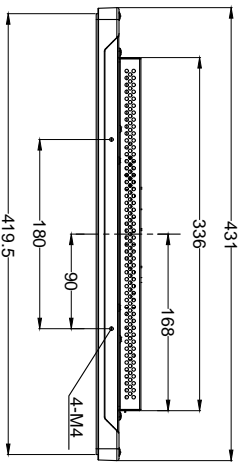

B

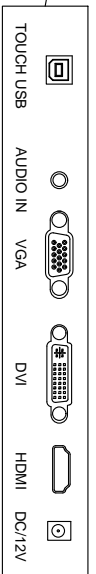

Tolerance Table	
Dimension Range	Tolerance(mm)
Under 25 mm	0.1
25.1-100 mm	0.2
100.1-250 mm	0.4
250.1-400 mm	0.8
400.1-500 mm	1.5
500.1-630 mm	2.0
630.1-800 mm	2.5

A

B

A

Rev	Date	Description	By
2			

**TOLERANCING**  
 UNLESS OTHERWISE SPECIFIED ALL DIMS ARE mm  
 X ±0.2 RADIUS ±0.15  
 .XX ±0.1 ANGLES ±0.5°  
 DO NOT SCALE DRAWING

<b>Title:</b> WTM190R-CU10		Design: Beng	Scale: NTS
Date: 2017.11.01		Sheet: 1 of 2	Ver: 01



THIRD ANGLE VIEW

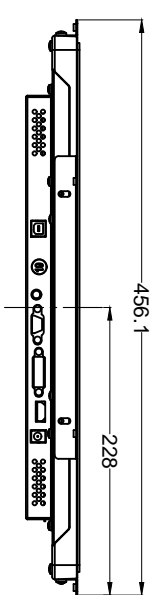
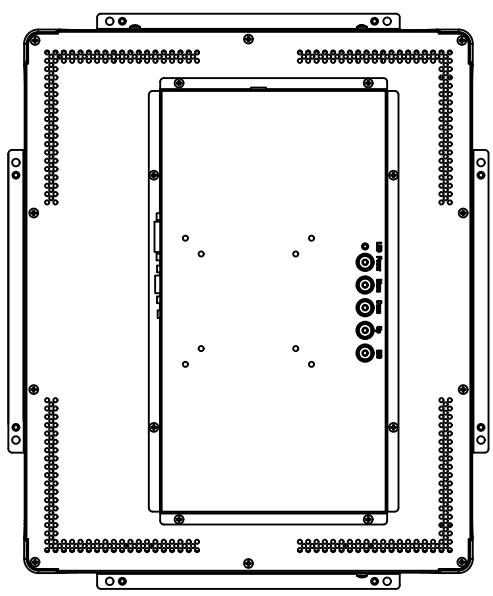
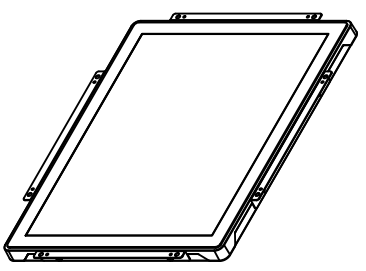
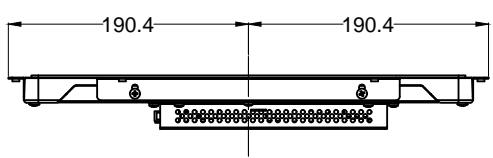
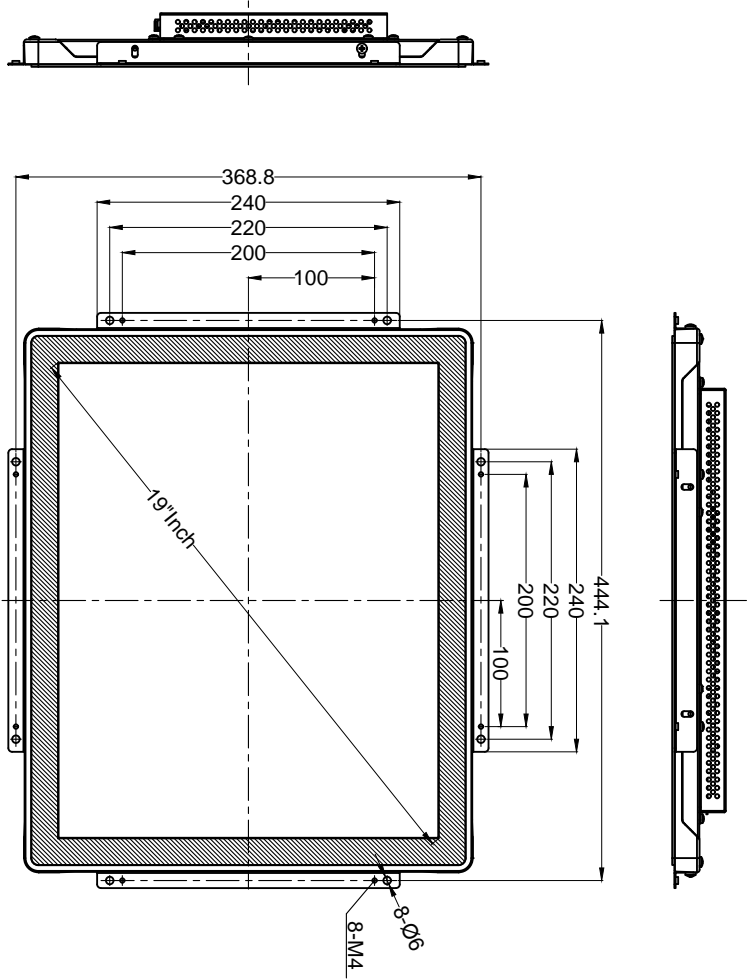

Tolerance Table	
Dimension Range	Tolerance(mm)
Under 25 mm	0.1
25.1-100 mm	0.2
100.1-250 mm	0.4
250.1-400 mm	0.8
400.1-500 mm	1.5
500.1-630 mm	2.0
630.1-800 mm	2.5

**TOLERANCING**

UNLESS OTHERWISE SPECIFIED ALL DIMS ARE mm

.X ±0.2

RADIUS ±0.15

.XX ±0.1

ANGLES ±0.5°

DO NOT SCALE DRAWING

**Title:** WTM190R-CU10

Design: Beng

Scale: NTS

Date: 2017.11.01

Sheet: 2 of 2

Rev	Date	Description	By
2			